

RestoreX[®]

Next Generation Penile Traction Therapy Device

**For the treatment of penile curvature, deformity, and length
and preservation of erectile function post-prostatectomy**

Developed in Cooperation with Mayo Clinic

 PathRight
MEDICAL
Your path to restored health

I N S T R U C T I O N S F O R U S E

Overview of Device

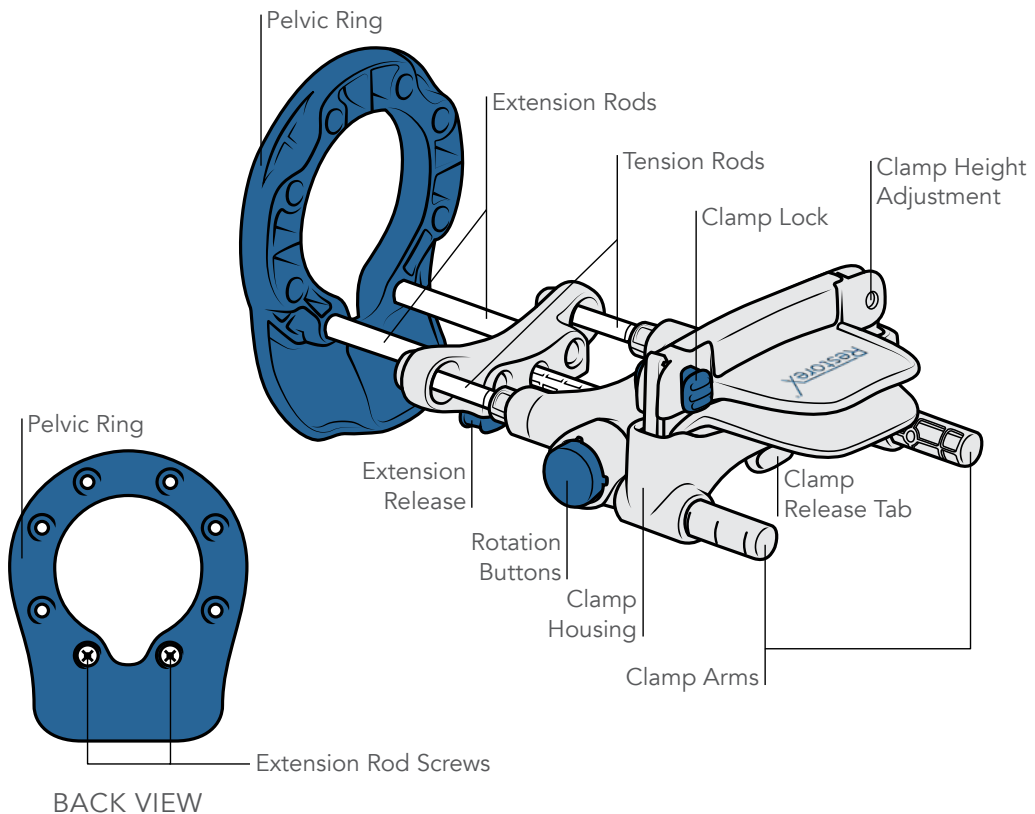

QUICK SETUP GUIDE

Step 1 – Adjust for Curve Direction (If Applicable)

Which most closely resembles your condition?



No changes required,
move to Step 2.

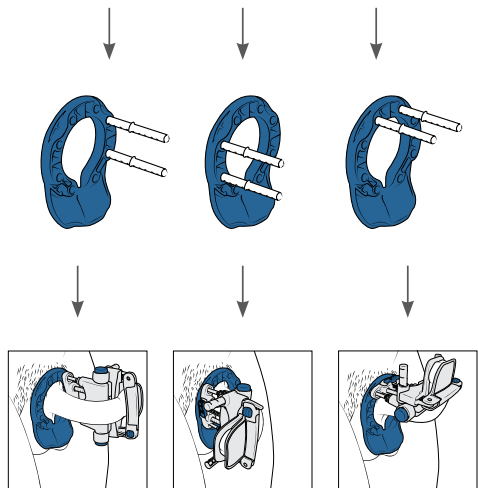

How to adjust rods (if applicable):

I

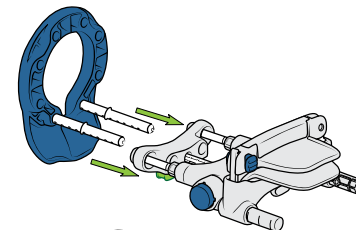
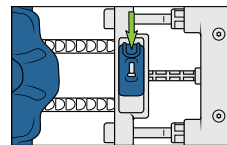

II

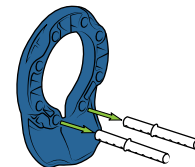
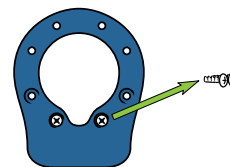

III

Place rods
according to
picture on left

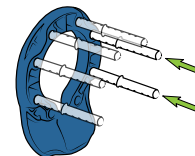

IV

Replace screws
to secure rods



Slide traction
device onto rods

Step 2 – Adjust Clamp Position (If Applicable)

What is your goal of treatment?

Lengthen only and/or preserve
erectile function

➔ No changes required, move to Step 3

Improve curve, indentation, hourglass, or
similar deformity in addition to length

➔

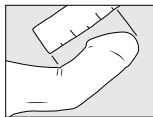

Less than 2 in
(5 cm)

2-3 in
(5-7.5 cm)*

More than 3 in
(7.5 cm)*

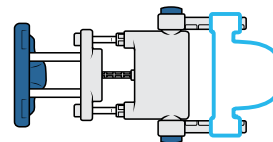
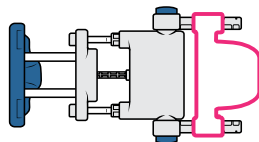
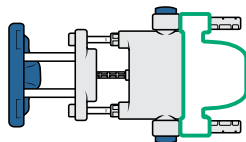

No changes required,
move to Step 3.

*Note: depending on penile length, positions 2 or 3 may not be possible.

How to adjust clamp (if applicable):

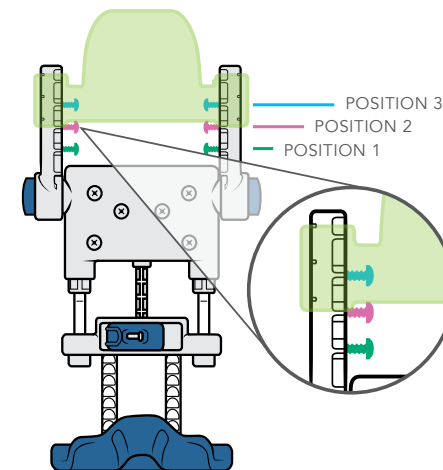
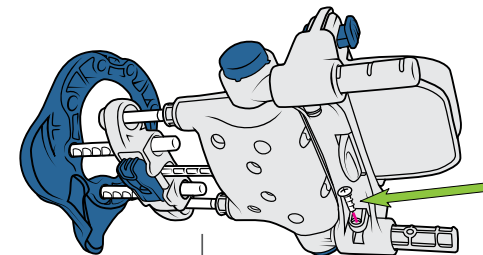

QUICK SETUP GUIDE

Step 3 – Additional Adjustments (As Needed)

Adjusting clamp height:

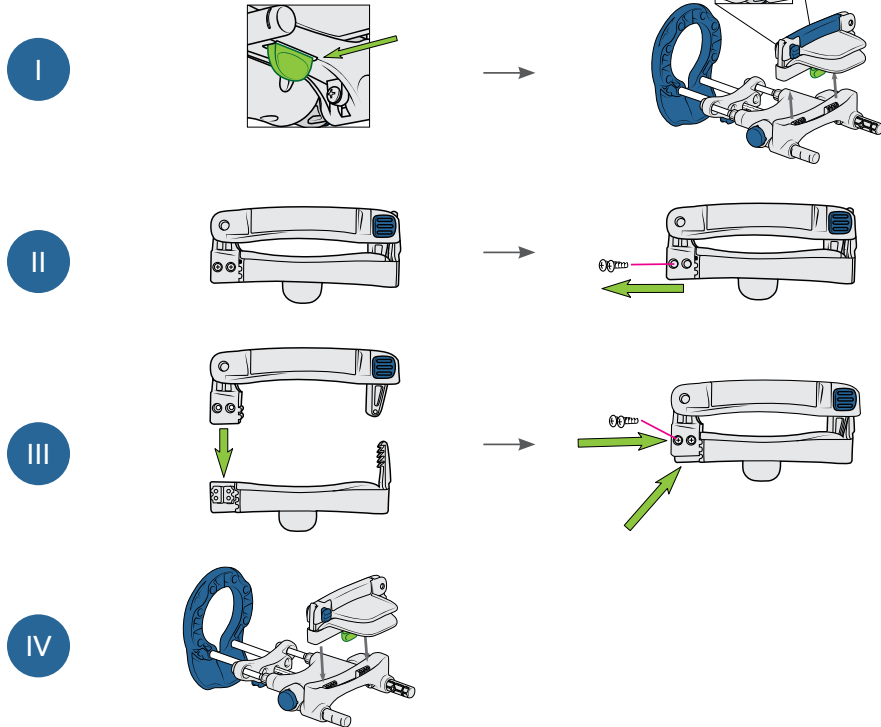

8

QUICK SETUP GUIDE

Step 3 – Additional Adjustments (As Needed)

Changing to longer rods:

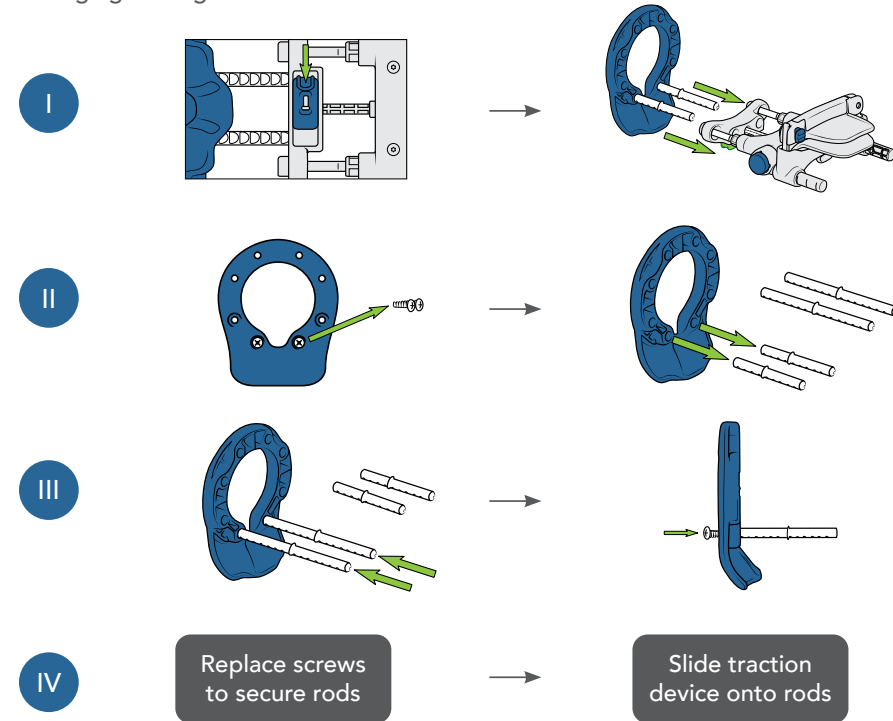

9

USING THE DEVICE

USING THE DEVICE

Key Principles to Optimize Outcomes

- Only use with a flaccid penis (not erect).
- Use 30-60 minutes daily – do not skip days if possible. Separate 30 minute treatment sessions by at least 30 minutes.
- The white bands should NOT be visible during use.
- The penile skin should be loose during use – you may need to pull in additional scrotal or penile skin during use.

For curves in the middle or end of the penis

↓
Get to the 3rd or 4th position
with counterbending:

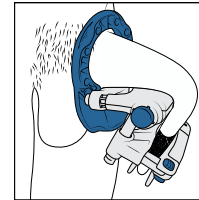

For curves near the base of the body

↓
Place a gauze roll at the base of the penis
between the penis and the device - only
use the first or second stop (30° or 60°)
when counterbending:

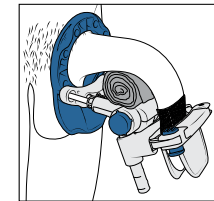

Scan the QR code for a video demonstration of device use:



USING THE DEVICE

Step 1 – Prepare

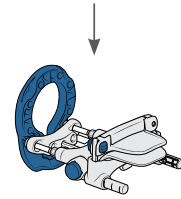
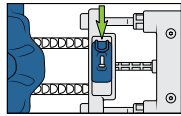

1a

Slide device back to beginning location.

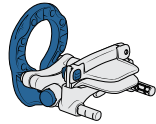
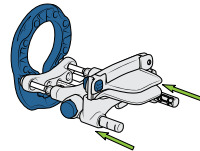

1b

Lock springs by pushing (compressing) device together.



1c

Wrap head of penis with self-adherent wrap or gauze.
**Note – pull back foreskin prior to placement if present.*

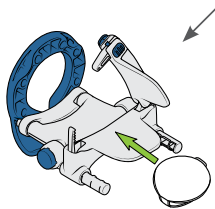

Option for added comfort.

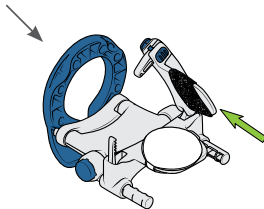

Option to prevent slipping out.

USING THE DEVICE

Step 2 – Clamp the Penis in the Device

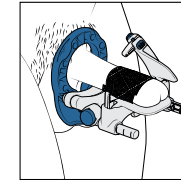

Place the flaccid (not erect) penis through the base ring and into the clamp.
**Note – rim of head of penis should be placed just inside of raised edge of clamp.*

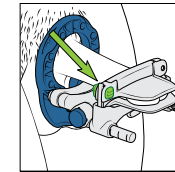
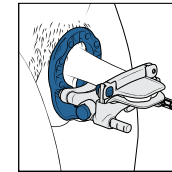

Clamp should be secured as tightly as possible (without causing pain) to prevent slipping out.

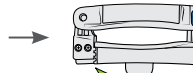
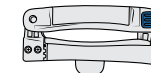

Optional height adjustment.
See page 8.

USING THE DEVICE

Step 3 – Add Straight Traction

I Extend

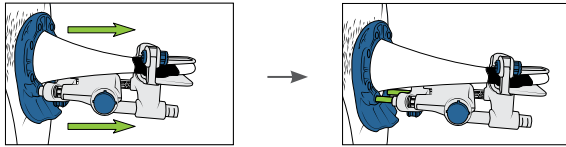

Extend device out as far as you are able.

II Release

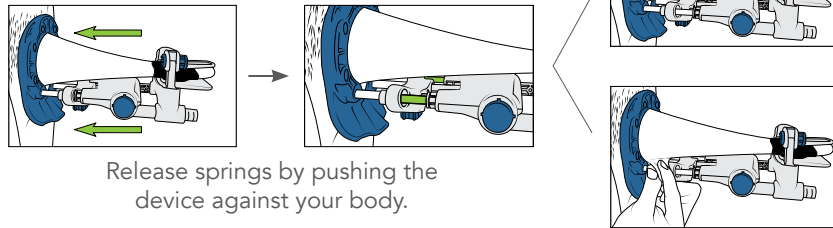

Release springs by pushing the device against your body.

Pull in additional penile and scrotal skin as needed to ensure that penile skin is loose while receiving traction.

USING THE DEVICE

Step 3 – Add Straight Traction

III Optimize

Verify amount of traction.

Indicator rod is not sufficiently compressed.

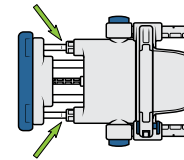

Indicator rod is nearly completely compressed.

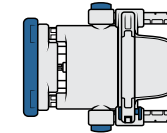

Lock the springs by pushing the device against your body.

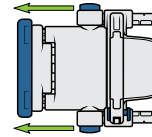

Advance the device 1 or more clicks until the penis is under maximal stretch.

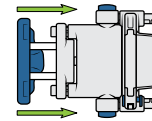

Release the springs by pushing the device against your body.

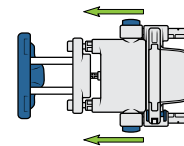

Optimal traction is being delivered.

Periodically check indicator rods to see if additional traction is required.

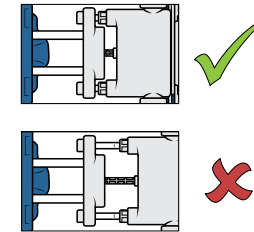

Step 4 – Counterbending (If Applicable)

Counterbending is only used in cases of penile curvature or indentation/hourglass deformities.

- I Fully collapse device while keeping the penis clamped. This is done by compressing the springs and sliding the device back to the base (Page 12, 1a and 1b)*
***Note – be very careful to avoid pinching scrotal skin as the device returns to the body.**

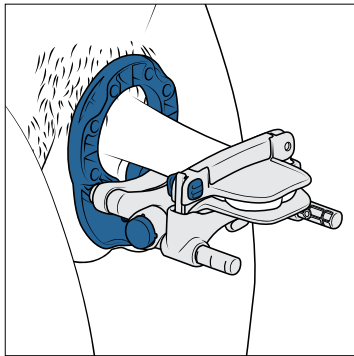

Step 4 – Counterbending (If Applicable)

Counterbending is only used in cases of penile curvature or indentation/hourglass deformities.

- II Counterbend the device by pressing the two side blue buttons simultaneously as shown to the right. For curves in the middle or end of the penis, get to the 3rd or 4th position (note: the 3rd position is shown in pictures).
 For curves near the base of the body, get to the 2nd position and place a gauze roll at the base of the penis as shown on page 11.
Note: for comfort, you may wish to wrap the shaft of the penis with gauze or toilet paper to allow it to slide more easily during counterbending.

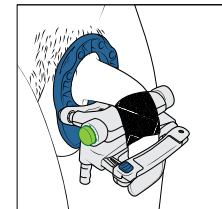
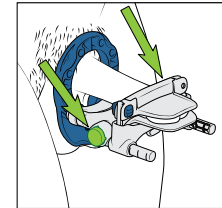

- III Extend the device by following steps as outlined in Step 3 with the device counterbent.

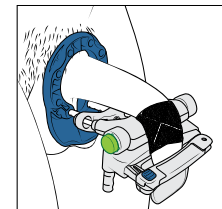

Step 4 – Examples of Counterbending

Which picture most closely matches your condition?

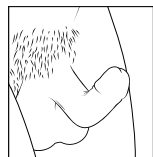

Up curve

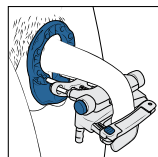
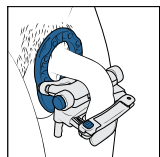

Right curve

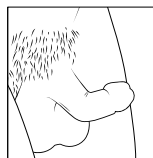
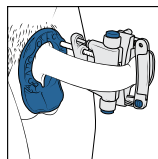
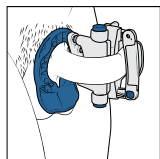

Left curve

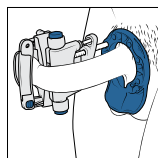
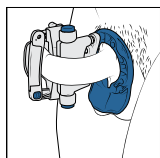

Step 4 – Examples of Counterbending

Which picture most closely matches your condition?

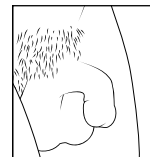

Down curve

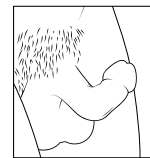
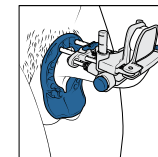
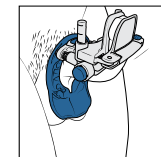

Up and side curve

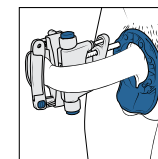
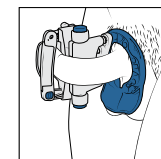
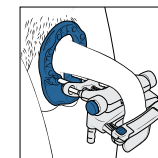
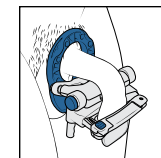
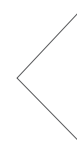

USING THE DEVICE

Step 4 – Examples of Counterbending

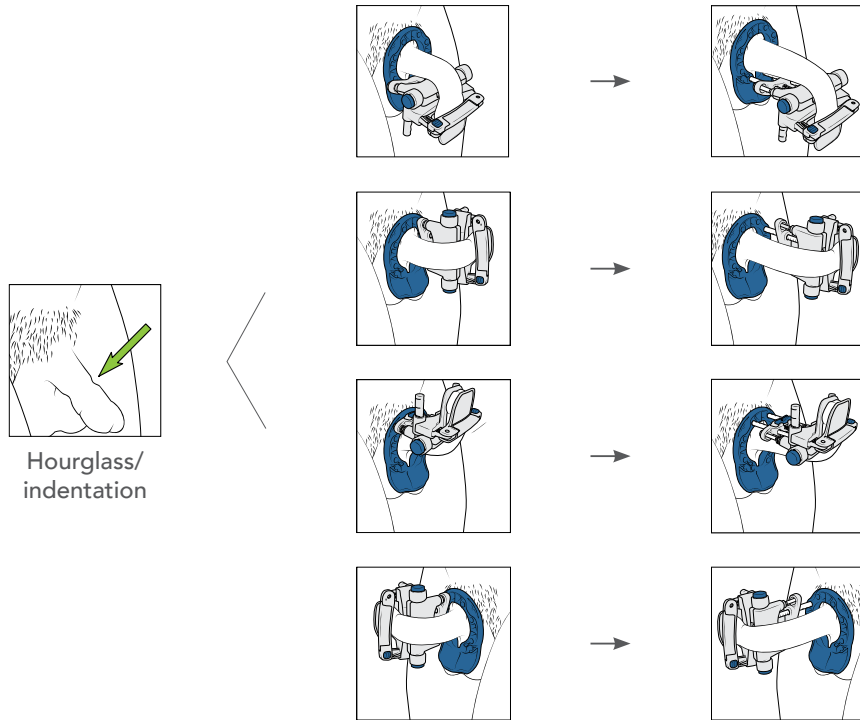

USING THE DEVICE

Step 5 – Remove the Device (After Treatment Completed)

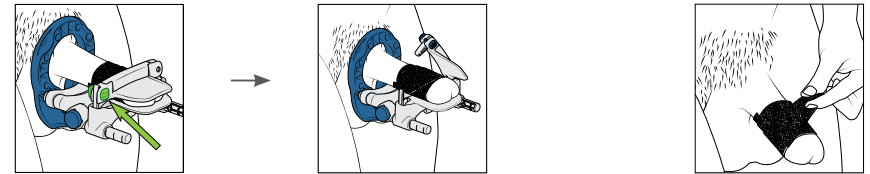

Press the release button to free the penis from the device.

Remove any penile wraps.

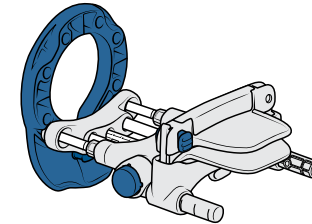

Store the device with the springs in the uncompressed state.

Notes on expected symptoms:

- It is normal for the head of the penis to be blue/cold while in the clamp.
- Discomfort is normal while using traction, particularly during the first 1-2 weeks of use.
- A small amount of decreased sensation is also normal during the treatment duration.
- Mild skin sensitivity from use of penile wraps is common.
- Discontinue use and contact your medical provider if you have any moderate or severe symptoms or symptoms which are persistent after discontinuing traction.

USING THE DEVICE

Recommended Treatment Times

Indication	Straight traction	Counterbending	How long to continue treatment
Lengthening only	30 min, 1-2x/day	None	3-9 months ¹
Post-prostatectomy	30 min, 1-2x/day starting 1 month post-op	None	5 months
Curve + length correction	15 min, 1-2x/day	15 min, 1-2x/day	3-9 months ^{1,2}
Hourglass narrowing	10 min, 1-2x/day	10 min, 1-2x/day in every direction except direction of curve (if present)	3-9 months ^{1,2}

¹ 3 months minimum; may continue up to 9 months if desired for additional improvements.

² For the first week of treatment, perform straight traction only. Counter-bending may be used beginning with the second week.

Intended Use

RestoreX is intended to correct penile deformities of curvature and lost length.

Patient Population

RestoreX is for males ages 18-75 with penile curvature and/or lost length due to Peyronie's disease, or those undergoing prostatectomy.

Indications for use:

- To correct penile curvature or indentation/hourglass deformity
- To increase penile length, and
- To limit loss of erectile function post-prostatectomy

Warnings:

- Do not use the device for longer than recommended, add additional traction to the device through the use of external materials such as weights, or overtighten the clamp as these may potentially result in pain or damage to the penile, testicular, or scrotal anatomy/physiology.
- Do not use a soiled or dirty device as this may potentially lead to infection.
- Use caution when clamping the head of the penis, locking the tension rods, and sliding the extension release as these may result in pinching of skin. This may potentially lead to bruising, bleeding, irritation, skin lacerations, swelling, or reduced sensation.
- Do not place the shaft of the penis in the clamp as this may potentially result in penile scarring.

Precautions:

- Ensure that all screws are securely fastened before use of the device.
- Do not use the device if it is damaged or place it in a dishwasher or microwave oven.
- Care should be taken while placing and removing wraps on the head of the penis to prevent skin erosion or bleeding.
- Discontinue use and consult a medical professional if you experience:
 - new or worsening pain in your scrotum, penis or abdomen.
 - new curvature or indentation.
 - persistent skin discoloration, irritation, bleeding, bruising or blistering.
 - decreased skin sensation.
 - pain with traction.
 - worsening of sexual function.

If any serious incident occurs, contact PathRight Medical and the competent authority in your location.

Contraindications:

Do not use RestoreX if:

- You have had penile, scrotal or pelvic surgery within the past six weeks unless otherwise indicated by your medical provider.
- You experience chronic penile pain not related to Peyronie's disease.
- You experience chronic testicular or scrotal pain.
- You have open sores or wounds on your penis.

RestoreX is not recommended for use in men with severe vascular disease including those who have:

- Absence of feeling in fingers, toes or limbs due to ischemia or neuropathy associated with diabetes or similar conditions, especially if the condition has resulted in loss of digits or limbs.
- Penile skin infections, open lesions or sores.

Troubleshooting:

1) It is difficult to use the device due to inability to see the penis.

- Remove the clamp from the clamp housing (Step 3, pg. 8).
- Once removed, place the penis through the pelvic ring. With the clamp out of the housing, secure the head of the penis in the clamp.
- Replace the clamp into its housing and continue with Step 1 on page 12.

2) Penis does not fit into device

- RestoreX accommodates stretched penile lengths of 3.75 in (10 cm). If you feel your stretched length is shorter than 3.75 in (10 cm), please attempt to re-measure using the instructions in Step 2 (pgs. 6-7) under "Quick Setup Guide." Most often, people underestimate their true penile length by not pushing the ruler deep enough into the fat pad located in the lower abdomen. The true stretched penile length should be measured from the tip of the penis to the pubic symphysis (or bone where the penis attaches).
- After re-measuring, if your stretched penile length is less than 3.75 in (10 cm), call PathRight Medical Customer Support for additional information.

3) Penis is too long to get a full stretch.

- Contact PathRight Medical Customer Support.

4) I need the long rods for straight stretch and short rods for counterbending

- Contact PathRight Medical Customer Support.

5) Penis keeps slipping out of the clamp whenever traction is applied.

See page 12 for additional methods to secure the head into the device clamp. The following may help prevent slippage and may be combined if needed.

- Uncircumcised - make sure to pull back all foreskin prior to wrapping the head of penis.
- Tighten the clamp (the clamp should not cause pain at rest).
- Wrap self-adherent wrap around the head of the penis.
- Use an additional comfort pad on the penile clamp.
- Wrap one or both clamp sides with comfort pads.

If slippage continues to occur despite these recommendations, contact PathRight Medical Customer Support.

6) Stretched penile length is greater than 6.25 in (15.875 cm) but with the clamp in position 2 or 3, the user cannot reach the first notch on the extension rods.

- In a few situations, the stretched penile length obtained in Step 2 (pgs. 6-7) will indicate to use the extended rods. However, if in Step 3 on pages 8-9, you move the clamp to position 2 or 3, you may not be able to use the extended rods due to the extra length in the overall device brought about by moving the clamp. If this happens, return to the standard rod and proceed with treatment.

7) What if my penis is too short for the angled position?

First, use position 1 for the clamp location (Step 2, pgs. 6-7). Second, begin each session with 15 minutes of straight traction before bending. Third, return RestoreX to its fully collapsed position before counterbending. If, after these steps, you are still unable to bend to the recommended position, bend as far as you are able and engage the traction. If helpful, wrap the shaft of the penis with gauze (wrap only once with gauze for prewrap), or something similar to allow it to slide over the RestoreX device more easily. If after all of these steps, you are still unable to bend to the 90 degree position (position #3), bend as far as you are able and engage the traction.

Troubleshooting (Cont.):

8) What if my curvature is further back on the penis than the point of bending?









This is acceptable. See pictures on pages 18-20 for recommendations on counterbending.

In a clinical trial evaluating RestoreX, curvatures that were closer to the body responded just as well as those that were directly over the point of bending. Bending is important because it allows more force to be applied to the direction of curvature than other areas of the penis. If the distance from the penis tip to the curvature of your penis is greater than 4 in (10.16 cm), only use the first or second stop (30° or 60°). Limiting the angle of opposite force will increase the tension applied to the disease location.

Care:

- Do not use a lubricant on RestoreX as it may permanently damage the device.
- Cleaning – To clean the device, wipe off any visible soil or contaminants from surfaces using a soft towel or facial tissue. Next, clean all surfaces of RestoreX using a cloth moistened with soap and water. DO NOT wash or immerse RestoreX in water, as this may damage the interior components. Allow RestoreX to air-dry thoroughly in a ventilated location before storing.

Dispose of the device according to your local regulations.

Symbol	Symbol Title	Description	Source
	Manufacturer	Indicates the medical device manufacturer.	ISO 15223-1 Ref. 5.1.1
	Date of Manufacture	Indicates the date when the medical device was manufactured.	ISO 15223-1 Ref. 5.1.3
	Catalogue number	Indicates the manufacturer's catalogue or model number.	ISO 15223-1 Ref. 5.1.6
	Batch code	Indicates the manufacturer's batch code.	ISO 15223-1 Ref. 5.1.5
	Consult instructions for use or consult electronic instructions for use	Indicates the need for the user to consult the instructions for use	ISO 15223-1 Ref. 5.4.3
	Unique device identifier	Indicates a carrier that contains unique device identifier information	ISO 15223-1 Ref. 5.4.3
	Patient information website	Indicates a website where a patient can obtain additional information on the medical product	ISO 15223-1 Ref. 5.7.4
	Authorized representative in the European Community/ European Union	Indicates the authorized representative in the European Community/ European Union	ISO 15223-1 Ref. 5.1.2
	Medical Device	Indicates the item is a medical device	ISO 15223-1 Ref 5.7.7

For more information, including online videos, additional troubleshooting, and more, visit us at www.restorex.com



Your path to restored health

Contact Us

1-877-228-5147

9 a.m. to 5 p.m. (CST), Mon-Fri
support@pathrightmedical.com

RestoreX.com

729-18-420051-01 Rev E

PathRight Medical, Inc.

1443 W 800 N, Suite 303
Orem, UT 84057

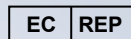

Obelis

BD General Wahis 53,
1030 Brussels, Belgium

Model #117

US Patent 10,117,771. November 6, 2018.



RestoreX is a registered trademark of PathRight Medical, Inc.